



Product / Technical Information

**LIGHTING THE FUTURE**  
HIGH PERFORMANCE  
AUTOMOTIVE HALOGEN BULBS



# LIGHTING THE FUTURE

## HIGH PERFORMANCE AUTOMOTIVE HALOGEN BULBS

As a technological leader in the field of intelligent light distribution, (be it halogen, xenon or full-LED headlights) and as a partner to renowned international vehicle manufacturers, HELLA always fulfills the highest expectations in product quality and performance.

### Dear customer:

This HELLA High Performance Bulbs brochure, provides a technical specification overview.

We have also included specific technical reference to our high performance bulb range.

HELLA covers a wide range of applications for all kinds of vehicles; passenger cars, trucks, special vehicles and motorbikes. HELLA's vast range includes headlights, sundry lights, interior lighting, classical halogen light as well as xenon light and all available at attractive prices.

We trust you will find this brochure informative and enhance your understanding of how HELLA High Performance Bulbs function.

**Your HELLA Automotive  
South Africa Team**

**A bulbs range benchmark is: top technology with no compromise in quality, founded on rigorous testing. This means optimum visibility thanks to top light quality and minimum failure rates thanks to durable and long lasting products.**

### FUNCTIONING

The lighting system of a motor vehicle consists of lighting and signalling devices mounted or integrated to the front, sides, rear, and in some cases the top of the motor vehicle. The purpose of this system is to provide illumination for the driver to operate the vehicle safely after dark, increase vehicle visibility, display information about the vehicle's presence, position, size, direction of travel and driver's intentions regarding direction and speed of travel.

A bulb can be considered as a replacement part with a limited service life. Yet the bulb is part of the lighting system. It is an active component of a unit where all the elements should be perfectly matched to one another.

### LIGHT SOURCES

Light sources are thermal radiators which convert heat energy into light. This means that the hotter a light source is, the higher the luminous intensity.

### FILAMENT BULB

Filament bulbs (vacuum bulbs) are thermal radiators and the supply of electric energy makes a tungsten filament glow. Generally, the light output of a standard bulb is low. Additionally, evaporated tungsten particles considerably blacken the bulb (see photograph below) and reduce all lighting values as well as service life.



### HALOGEN BULBS

By adding small amounts of halogen atoms such as iodine, the blackening of the bulb is reduced. The so-called "cyclic process" enables operation of halogen bulbs at higher temperatures and thus with improved efficiency with the same useful life.

## MAIN COMPONENTS

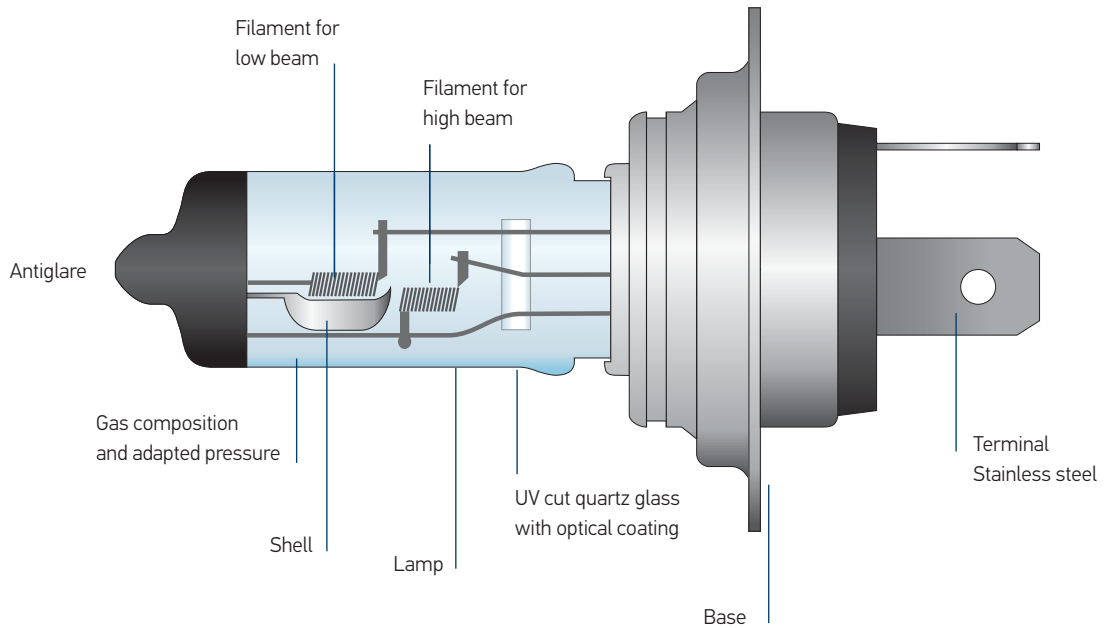

### H4 Type Bulb

### CYCLIC PROCESS INSIDE A HALOGEN BULB

Supply of electronic energy makes the filament glow and metal evaporates off the filament. A halogen filling (iodine or bromine) inside the bulb lets the filament temperature rise to near the melting point of the tungsten (around 3 400°C) and this causes the high light output. In the immediate vicinity of the hot bulb wall, the evaporated tungsten combines with the filling gas (tungsten halogenide) to form a gas which is transparent.

However, once the gas gets back near the filament, it disintegrates due to the high filament temperature and forms an even tungsten layer. For the cyclic process to stop, the outer temperature of the bulb must be 300°C. The bulb made of quartz glass must closely enclose the filament.

Another advantage is that a higher filling pressure can be used to counteract the evaporation of the tungsten. The gas composition in the bulb is also a major factor controlling the light output.

Inclusion of a small amount of a noble gas such as xenon reduces the heat transfer away from the filament. However, despite the regeneration process inside the bulb, the tungsten filament is slowly consumed and thus service life is limited.

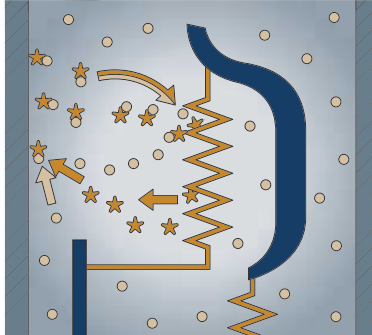

- 1 Tungsten filament
- 2 Halogen filling (iodine or bromine)
- 3 Evaporated tungsten
- 4 Tungsten halogenide
- 5 Tungsten deposits

### INFLUENCING FACTORS ON A BULB

#### Negative influencing factors

- Mechanical stress due to impacts and vibration
- High temperatures
- Switching-on process
- Glitches and excessive on-board voltage
- High luminance due to extreme filament density

#### Positive influencing factors

- Filling pressure
- Filling gas

### Cross-section of temperature zones

Cross-section through the temperature (°C) zones of a halogen bulb.

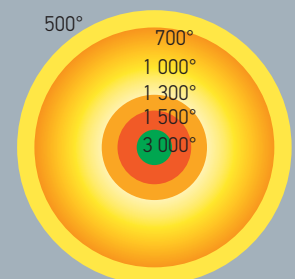

Top view - Lamp

# COLOUR TEMPERATURE

Colour temperature is a measurement in degrees Kelvin that indicates the hue of a specific type of light source. (Kelvin is indicated by the unit symbol K.)

Colour temperatures over 5000K are called cool colours (blueish white), while lower colour temperatures (2700 – 3000K) are called warm colours (yellowish white through red).

The higher the temperature of a light source is, the greater the proportion of blue and the lower the proportion of red in the colour spectrum. An incandescent light bulb has a warm white colour temperature of approx. 2700K.

The illustration below provides an indication of the colour temperature spectrum.

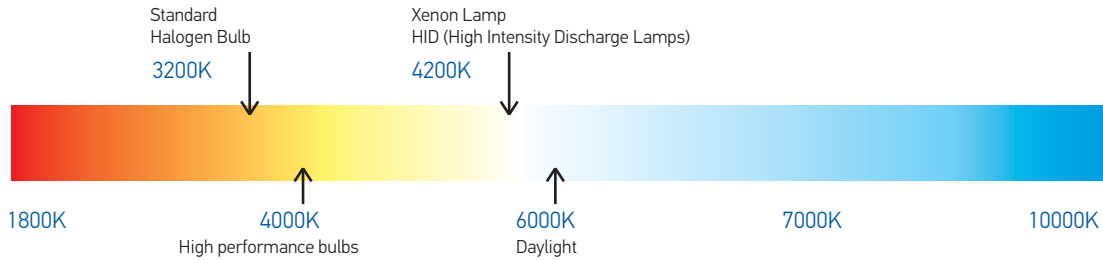

# LIFE EXPECTANCY OF A BULB

Service life and light efficiency among other things strongly depend on the supply voltage used.

Therefore, protective resistors are used in some vehicle types to ensure that the supply voltage doesn't exceed 13.2 V. On the other hand, undervoltage, e.g. due to a defective generator, means exactly the opposite. The light now has a considerably higher red fraction and thus light efficiency is lower.

LIFE EXPECTANCE DEPENDENT ON VOLTAGE

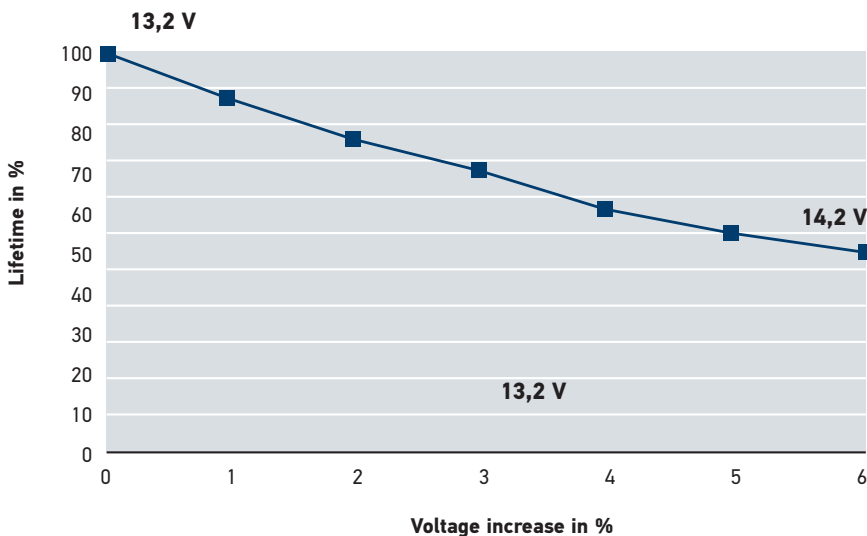

**Rule of thumb:** If the supply voltage of a bulb is increased by 5%, then the luminous flux increases by 20%, but at the same time service life is halved.

## REPLACEMENT AND INSTALLATION

- When inserting a new bulb, you should not touch the glass bulb, because fingerprints may burn in and leave "clouds" on glass
- Standard filament and halogen bulbs do not contain environmentally relevant substances and can be disposed of as household waste
- Check the local regulations to ensure correct disposal
- HELLA recommend to replace both bulbs when a bulb has blown



## TESTED QUALITY

All HELLA bulbs undergo thorough testing. The engineers in HELLA's Quality Assurance department have specified a clear requirement profile for every bulb type.

Headlight bulbs, are tested by our engineers for their light distribution properties. The very latest in light measuring equipment is used for this. Paint adhesion tests in accordance with FAKRA guidelines (German Association of Automotive Experts), vibration and shock tests in line with IEC requirements, geometry measurements, light flux and power measurements as well as service life tests guarantee that wholesalers and garages receive perfect quality.

Quality assurance is very important to us: Thanks to these extensive tests and our knowledge as an OE lighting expert, you can trust that we guarantee you top quality.

As a result of this consistent quality testing, renowned vehicle manufacturers have been relying on our technological innovations for years, and trust HELLA expertise, experience and quality.

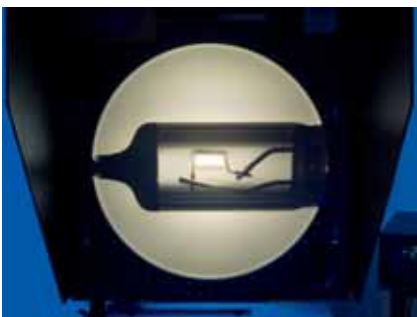

### Geometrical Measurement

A measuring projector is used to check the filament geometry - with regard to the statutory standards in accordance with IEC 60810. The filament must be dimensioned and positioned within the bulb as specified in the standard. This is the only way to achieve optimum headlight power and prevent glare to oncoming traffic.



### Vibration and Shock Test

Here, vibration resistance of the bulb and the filament in particular, is tested on an electro-dynamic vibration table.



### Paint Adhesion Test

The adhesion of paint on coloured glass bulbs – such as the PY21W for example – is tested in a climate chamber at different temperatures and air humidities. Optimum adhesion of glass bulb paint guarantees the prescribed amber indicator light over the whole service life period.



### Life Test

Sophisticated tests are used to prove the high reliability of the HELLA bulbs over a long period.



### Light Flux Measurement

The Ulbricht sphere and goniometer are used to determine the light fluxes and luminous intensities of the HELLA bulbs. This guarantees optimum light output of the bulbs.



The aforementioned tests and measurements form the basis of our tested quality.



# LONG LIFE



Plastic case includes 2 pieces

## LIFE SPAN: FOR A LONGER LIFE SPAN

The special design of Long Life bulbs for passenger cars guarantees a longer service life, more light performance and reduced energy consumption, making them ideal for frequent drivers and permanent use of daytime running lights.

Long Life represents bright but glare-free light. Good performance under extreme conditions encountered by construction

machinery or off-road vehicles. Long Life combines unusual sturdiness and vibration resistance with convincing brightness and long service life.

The single-coil technology makes Long Life for trucks glare-free and extremely powerful. In addition, the longer service life halves the costs for spare parts and downtime.

### Features:

- More 200% longer life time than standard bulbs.
- Specially designed by halogen mixing gas & filament.
- Meets global standard (ECE R37 & SAE/DOT regulation).

Product photo	Dimensional drawing	Product designation	Base	Power	Voltage	Colour temperature	Part number	Short part number
		H1 LONG LIFE	P14.5s	70 W	24 V	3200K	8GH-178555-412	G5412LL
		H4 LONG LIFE	P43t	75/70 W	24 V	3200K	8GJ-178555-432	G5432LL
		H7 LONG LIFE	PX26d	70 W	24 V	3200K	8GH-178555-442	G5442LL



Plastic case includes 2 pieces

## NIGHT VISION +

### YELLOW-RING COATING TECHNOLOGY

Thanks to our up-to-date technology, HELLA Night Vision performance bulbs light up the roadway more than standard bulbs.

The optimised illuminant and a special coating process used on the glass bulb enhances vision and therefore improves the reaction time.

#### Features:

- Special yellow-ring coating at filament position.
- Delivers yellowish and soft light towards driving direction.
- Meets global standard (ECE R37 & SAE/DOT regulation).

Product photo	Dimensional drawing	Product designation	Base	Power	Voltage	Colour temperature	Part number	Short part number
		H4 NIGHTVISION +	P43t	60/55 W	12 V	3000K	8GJ-178555-472	G5472NV
		H7 NIGHTVISION +	PX26d	55 W	12V	3000K	8GH-178555-482	G5482NV



# PLATINUM +50







Plastic case includes 2 pieces

## PERFORMANCE: FOR MORE LIGHT

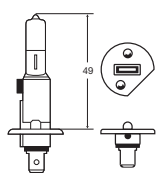
The Platinum +50 version produces 50 percent more light (compared to standard bulbs) and extends the light cone by around 20 meters, giving performance-oriented drivers additional safety time in case of an emergency situation.

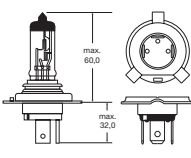
- Features:**
- Delivers 50% more light on the road.
  - Up to 20 meters longer light beam compared to standard bulbs.
  - Meets global standard (ECE R37 & SAE/DOT regulation).

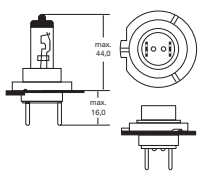
Product photo	Dimensional drawing	Product designation	Base	Power	Voltage	Colour temperature	Part number	Short part number
		H1 PLATINUM +50	P14.5s	55 W	12 V	3200K	8GH-178555-051	G5051PL
		H4 PLATINUM +50	P43t	60/55 W	12 V	3200K	8GJ-178555-492	G5492PL
		H7 PLATINUM +50	PX26d	55 W	12 V	3200K	8GH-178555-502	G5502PL





# DAYMAKER +80







## MORE POWER

The optimised illuminant and a special coating process used on the glass bulb allows the Daymaker +80 version to achieve up to 80 percent more light than comparable standard halogen bulbs, giving drivers more driving pleasure and maximum safety.

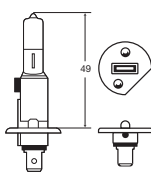
### Features:

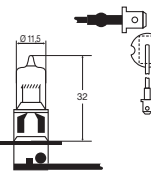
- Delivers 80% more light on the road.
- Up to 40 meters longer light beam compared to standard bulbs.
- Special blue-coating deliver white & clear lights.
- Meets global standard (ECE R37 & SAE/DOT regulation).

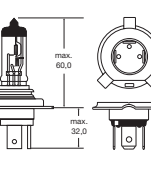
Plastic case includes 2 pieces

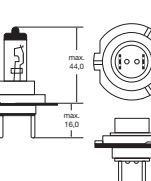
Product photo	Dimensional drawing	Product designation	Base	Power	Voltage	Colour temperature	Part number	Short part number
		H1 DAYMAKER+80	P14.5s	55 W	12 V	3500K	8GH-178555-532	G5532DM
		H3 DAYMAKER+80	PK22s	55 W	12 V	3500K	8GH-178555-512	G5512DM
		H4 DAYMAKER+80	P43t	60/55 W	12 V	3500K	8GJ-178555-542	G5542DM
		H7 DAYMAKER+80	PX26d	55 W	12 V	3500K	8GH-178555-552	G5552DM



# XENON BLUE



Plastic case includes 2 pieces





## DESIGN: FOR INCREASED DEMANDS

Special demands on design and driving safety are met by our modern design bulbs. With its cool xenon effect, Xenon Blue light is a real alternative for design-oriented drivers. Thanks to the high 4000K temperature, similar to a xenon bulb, the Xenon Blue version provides up to 20 percent more brightness.



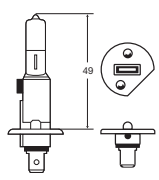

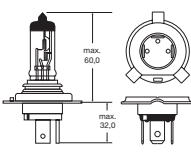
The whitish-blue light ensures better illumination, driving comfort and safety.

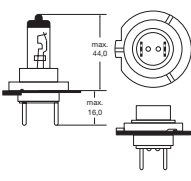
### Features:

- Brilliant 4000K white daylight.
- Sharper view and better concentration.
- Meets global standard (ECE R37 & SAE/DOT regulation).

Product photo	Dimensional drawing	Product designation	Base	Power	Voltage	Colour temperature	Part number	Short part number
		H1 XENON BLUE	P14.5s	55 W	12 V	4000K	8GH-178555-171	G5171XB
		H4 XENON BLUE	P43t	60/55 W	12 V	4000K	8GJ-178555-121	G5121XB
		H7 XENON BLUE	PX26d	55 W	12 V	4000K	8GH-178555-572	G5572XB

## HIGH PERFORMANCE AUTOMOTIVE HALOGEN BULBS PRODUCT RANGE

	H1	H3	H4	H7	VOLTS
 <p><b>LONG LIFE</b> Brilliant 3200K white light, 50% more light and harmonised light colour.</p>	G5412LL	-	G5432LL	G5442LL	24V
 <p><b>NIGHT VISION+</b> Special yellow-ring coating at filament position</p>	-	-	G5472NV	G5482NV	12V
 <p><b>PLATINUM +50</b> Offers 50% more light and 20m longer light beam</p>	G5051PL	-	G5492PL	G5502PL	12V
 <p><b>DAYMAKER +80</b> Offers 80% more light and 40m longer light beam compared to standard bulbs.</p>	G5532DM	G5512DM	G5542DM	G5552DM	12V
 <p><b>XENON BLUE</b> Brilliant 4000K white light, light colour harmonised with HID in effect &amp; colour.</p>	G5171XB	G1787XB	G5121XB	G5572XB	12V

HELLA high performance bulbs offer optimum quality and are best suited to individual demands.

The reliable and cost effective bulbs lead the way to a future with better vision and more safety on the road.

- » Longer life time.
- » Sharp view and better concentration.
- » Maximum safety and visibility.
- » Optimised premium filament design.
- » Stylish and powerful lights on the road.



**Hella Middle East FZE**

Jebel Ali Free Zone  
LOB 19, Office 501-502  
P.O. Box 17002  
Dubai, United Arab Emirates

**Sales Telephone:** +971 (0) 4899 6000

**Sales Telefax:** +971 (0) 4884 7309

<http://www.hella.ae>